

# MA-5444V2

4X4 HDBaseT Lite Matrix with PoC,  
HDCP2.2 & 4K2K60 (YUV420)

## User Manual



rev: 151209  
Made in Taiwan



## Safety and Notice

The **MA-5444V2 4x4 HDBaseT Lite matrix with PoC, HDCP2.2 & 4K2K60 (YUV420)** has been tested for conformance to safety regulations and requirements, and has been certified for international use. However, like all electronic equipments, the **MA-5444V2** should be used with care. Please read and follow the safety instructions to protect yourself from possible injury and to minimize the risk of damage to the unit.

- Follow all instructions and warnings marked on this unit.
- Do not attempt to service this unit yourself, except where explained in this manual.
- Provide proper ventilation and air circulation and do not use near water.
- Keep objects that might damage the device and assure that the placement of this unit is on a stable surface.
- Use only the power adapter and power cords and connection cables designed for this unit.
- Do not use liquid or aerosol cleaners to clean this unit. Always unplug the power to the device before cleaning.



### TABLE OF CONTENTS

INTRODUCTION.....	1
FEATURES.....	1
PACKAGE CONTENTS .....	1
SPECIFICATIONS .....	2
PANEL DESCRIPTIONS.....	3
Transmitting unit ► MA-5444V2.....	3
Receiving unit ► CV-745V .....	4
IR PASS-THROUGH.....	5
CONNECTION DIAGRAM .....	6
OPERATION APPROACH .....	7
EDID LEARNING .....	19
FAQ .....	20
NOTICE .....	21
WARRANTY .....	22

# INTRODUCTION

The **MA-5444V2 4x4 HDBaseT Lite matrix with PoC, HDCP2.2 & 4K2K60 (YUV420)** provides the most flexible and cost effective solution in the market to route high definition video sources plus multi-channel (up to 7.1-channel) digital audio from any of the four HDMI sources to the remote displays at the same time. Through only one low cost Cat-5/5e/6 LAN cables, not only high quality video and audio can be transmitted to the display sites, but also users can switch among four HDMI sources using the push button or remote control. Furthermore, the built-in IR extension function makes users at display site access the DVD player, PS3 or any HDMI supported devices directly! In addition, MA-5444V2 also supports PoC (Power over Cable) which can power both units from TX with power supply.

## FEATURES

- Supports HDMI Deep Color, full 3D, 4K2K@60Hz (YUV 4:2:0)
- Extends the HDMI transmission up to 70m (230ft) from the HDMI source at Full HD 1080p 48-bit, and 40m (130ft) at 4K2K@60Hz (YUV 4:2:0)
- Supports PoC(Power over Cable) which can power both units from TX side with power supply
- HDCP1.4 & HDCP2.2 compliant
- Bi-directional IR pass-through
- Allows controlling local HDMI sources or display through control path
- Allows controlling matrix switcher from IR remote
- Pure unaltered uncompressed 7.1ch digital HDMI over Cat.5/5e/6 cable transmission
- Allows any source to be displayed on multiple displays at the same time
- Allows any HDMI display to view any HDMI source at any time
- Supports 7.1 channel digital audio
- Supports default HDMI EDID and learns the EDID of displays to matrix switcher
- The matrix switcher can switch every output channels from any HDMI inputs by Push button, IR remote control, RS-232, IP control and web-interface control
- Easy installation with rack-mounting
- Fast response time – 2~4 seconds for channel switch

## PACKAGE CONTENTS

- 1x MA-5444V2
- 5x IR receiver
- 1x Rack-mounting ear set
- 1x Installation software CD
- 1x DC 24V 3.75A
- 4x IR blaster\*
- 1x IR Remote control\*
- 1x User Manual



\* Additional IR remote controllers and IR blasters can be purchased as optional accessories to control the HDMI sources located separately.

# SPECIFICATIONS

Model Name	MA-5444V2	
Technical	MA-5444V2	CV-745V
Role of usage	True 4x4 matrix switcher Transmitter [TX]	Receiver [RX]
HDMI compliance	HDMI Deep Color, full 3D & 4K2K@60Hz (YUV 4:2:0)	
HDCP compliance	Yes	
Video bandwidth	Single-link 340MHz [10.2Gbps]	
Video support	480i / 480p / 720p / 1080i / 1080p60 / 4K2K@60Hz (YUV 4:2:0)	
Audio support	Surround sound (up to 7.1ch) or stereo digital audio	
PoC support	YES	
HDMI over UTP transmission range	1080p@60 – up to 70m (230ft) [CAT.X] 4K2K@60(YUV 4:2:0) – 40m (130ft)	
Input TMDS signal	1.2 Volts [peak-to-peak]	
Input DDC signal	5 Volts [peak-to-peak, TTL]	
ESD protection	[1] Human body model — ±19kV [air-gap discharge] & ±12kV [contact discharge]	
PCB stack-up	4-layer board [impedance control — differential 100Ω; single 50Ω]	
Input	4x HDMI / 1x RS-232 / 1x RJ-45 for IP Control / 5x IR socket for IR receiver	1x RJ-45(HDBaseT) / 1x IR socket for IR receiver
Output	4x RJ-45(HDBaseT) / 4x HDMI / 5x IR socket for IR blaster	1x HDMI / 1x IR socket for IR blaster
HDMI Input selection	Push button / IR remote control / RS-232 control / IP control	IR remote control
HDMI source control	Controllable via IR pass-through from IR receiver at RX to IR blaster at TX	
IR remote control	Electro-optical characteristics: $\pi = 25^\circ$ / Carrier frequency: 30-56kHz	
HDMI connector	Type A [19-pin female]	
RJ-45 connector	WE/SS 8P8C	
RS-232 connector	DE-9 [9-pin D-sub female]	N/A
3.5mm connector	1. Earphone jack for IR blaster <b>[All IR Out]</b> IR signal from all outputs <b>[IR1~IR4]</b> IR control on individual source device 2. Earphone jack for IR receiver <b>[System IR]</b> Receives IR commands from remote control <b>[IR1~IR4]</b> Receives IR commands from individual remote control	1. Earphone jack for IR blaster <b>[IR]</b> IR control on individual display device 2. Earphone jack for IR receiver <b>[IR]</b> Receives IR commands from remote control
Mechanical	MA-5444V2	CV-745V
Enclosure	Metal case	
Dimensions (L x W x H)	Model	440 x 160 x 41mm [1'4" x 6.3" x 1.6"]
	Package	526 x 318 x 156mm [1'7" x 12.5" x 6.1"]
	Carton	543 x 335 x 344mm [1'8" x 13.2" x 1'1"]
Weight	Model	1800g [4 lbs]
	Package	3.5kg [7.7 lbs]
Fixedness	1RU rack-mount with ears Wall hanging holes	Wall-mount with screws
Power supply	24V 3.75A DC	None
Power consumption	70 Watts [max]	None
Operation temperature	0~40°C [32~104°F]	
Storage temperature	-20~60°C [-4~140°F]	
Relative humidity	20~90% RH [no condensation]	

# PANEL DESCRIPTIONS

## Transmitting unit ▶ MA-5444V2

### Front Panel

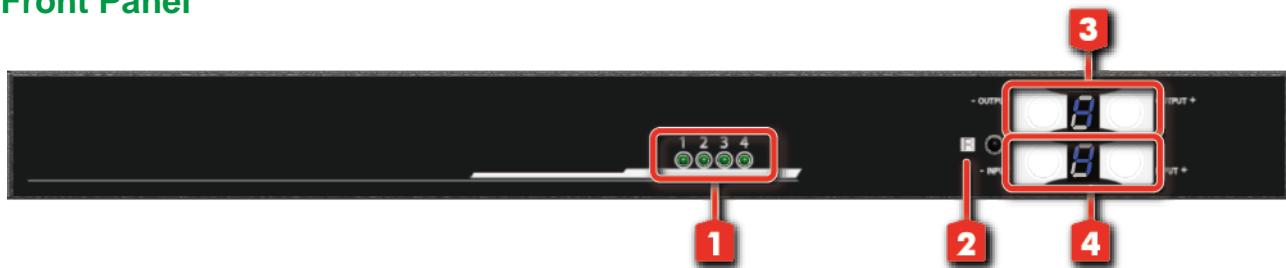

- 1. Source Status:** Input source indicator LED
- 2. IR SENSOR:** IR sensor for receiving the IR commands from IR remote
- 3. Output Push Button & 7-segment LED:** Front panel push buttons used to select the number of display channel & LED display for output ports
- 4. Input Push Button & 7-segment LED:** Front panel push buttons used to select the number of input source & LED display for input channels

### Rear Panel

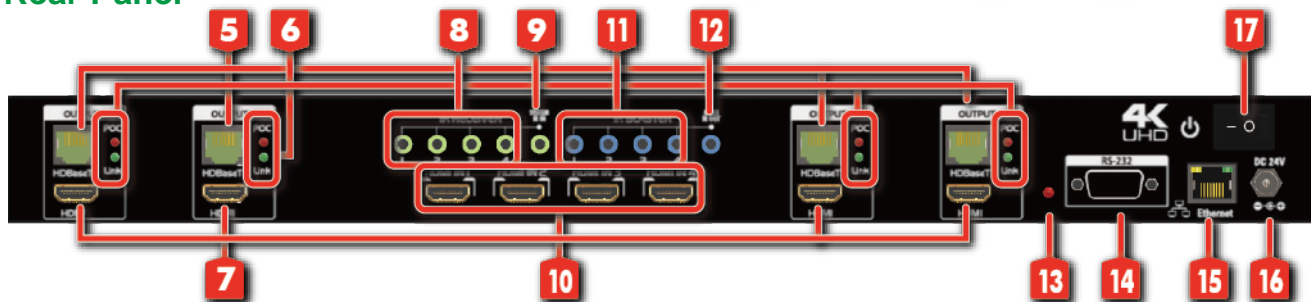

- 5. RJ-45:** HDBT output port 1-4
- 6. LED:** Link/ PoC indicator
- 7. HDMI Local Loopout Port 1-4:** Local loopout HDMI outputs for each output channel
- 8. IR Receiver 1-4:** Infrared 3.5mm socket for plugging in the extension cable of IR receiver
- 9. System IR Receiver:** Ext. IR receiver
- 10. INPUT 1-4:** HDMI inputs
- 11. IR Blaster 1-4:** 3.5mm IR blaster socket for individual HDMI source control
- 12. All IR Output:** 3.5mm IR blaster socket for HDMI source control on all 4 inputs
- 13. LED:** Power indicator
- 14. RS-232:** RS-232 control port
- 15. Ethernet:** Ethernet control port
- 16. +24V DC:** 24V DC power jack
- 17. Power Switch**

## Receiving unit ► CV-745V

Front Panel

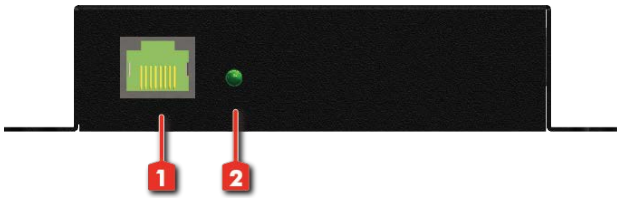

Rear Panel

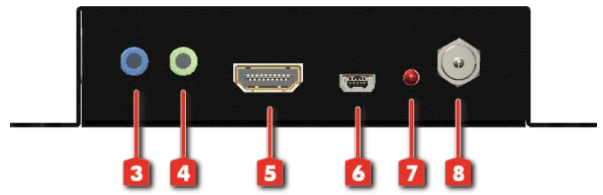

1. **RJ-45:** Plug in a Cat.X cable
2. **LED:** Power indicator
3. **IR Blaster:** Infrared 3.5mm socket for plugging in the extension cable of IR blaster
4. **IR Receiver:** Infrared 3.5mm socket for plugging in the extension cable of IR receiver
5. **HDMI Output:** Connect to HDTV with a HDMI cable
6. **Mini-USB:** F/W update
7. **LED:** Power indicator
8. **+24V DC:** Doesn't require power here

# IR PASS-THROUGH

## IR Extenders

IR Blaster



IR Receiver



## IR Sockets

### MA-5444V2

**All IR Out:** The default location for IR blaster to transmit all IR command signals received from any of the four remote receivers to all of the HDMI sources.

**IR BLASTER 1-4:** IR blaster connected here can only transmit IR command signals from the remote receivers that are setting at respective input channel from 1 to 4.

**System IR:** Receives IR commands from remote control

**IR RECEIVER 1-4:** Receives IR commands from individual remote control

### CV-745V

**IR BLASTER:** IR control on individual display device

**IR RECEIVER:** IR receiver connected here can receive all IR command signals from the IR remote controls of MA-5444V and all other HDMI source devices.

## CAUTION!

*Incorrect placement of IR Blaster and Receiver may result in the failure of the IR extenders. Please check carefully before plugging in the IR extender to the respective IR sockets. Warranty will not cover the damage.*

## Definition of IR Earphone Jack

IR Blaster

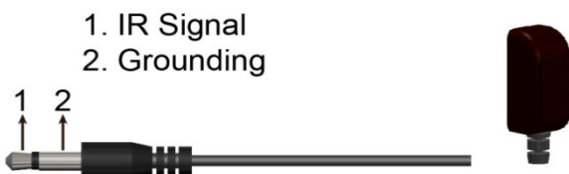

IR Receiver

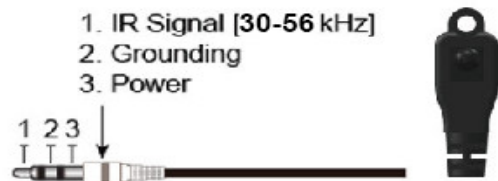

You can buy any IR extension cables in the market that are compatible to the definition of the IR sockets for the matrix if necessary for replacement use. However, IR cables longer than 2m (6-ft) may not work.

# CONNECTION DIAGRAM

- HDMI
- CAT5/5e/6
- IR (outgoing)
- IR (incoming)
- RS-232



**MA-5444V2**



FRONT

Up to 70m/230ft at 1080p  
40m/130ft at 4K2K

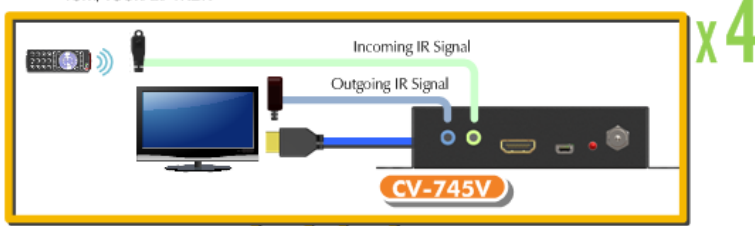

**Control System**



CAT 5/5e/6

x4  
IR-Transmitter

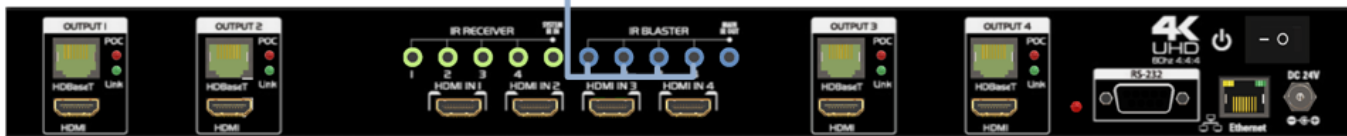

REAR

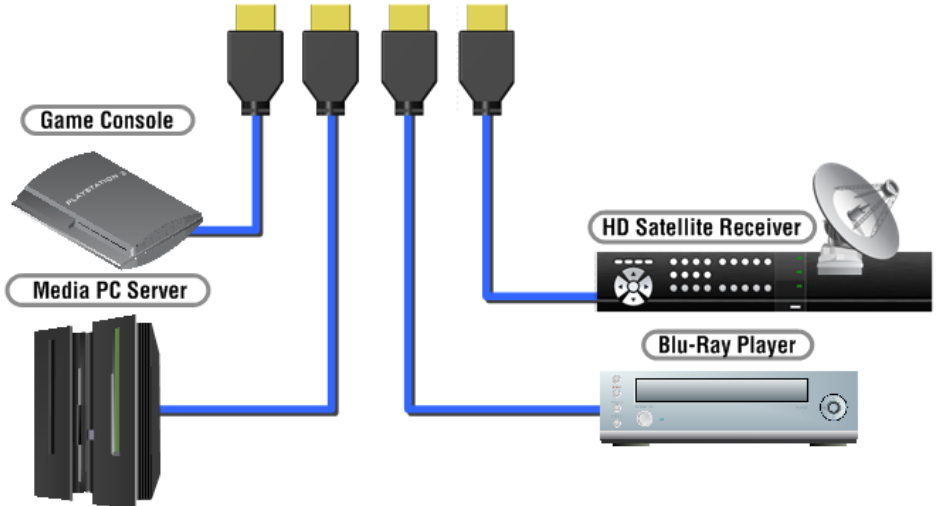



# OPERATION APPROACH

## Method A: Push-in Button



### 1. IN/OUT MAP

- 1) Use the “+” or “-” output push button to select the number of display
- 2) Use the “+” or “-” input push button to select the number of input source
  - “+”: change selected input/output port in ascending order
  - “-”: change selected input/output port in descending order

After you select the desired input/output port, the LED will blink twice and the setting will be effective

### 2. Save Mapping Mode

- 1) Keep pushing “output+ (save)” button until the output LED shows “d.” to enter the Save Mapping Mode.
- 2) Use the “+” or “-” input push button to select the mapping configuration (1~8) which you want to save current input/output mapping
- 3) After you select the desired mapping configuration number, the LED will blink twice and the mapping setting will be saved
- 4) If you push the “output- (preset)” button before the mapping setting is saved, the LED will show “\_” “\_” to quit the Save Mapping Mode

### 3. Preset Mapping Mode

- 1) Keep pushing “output- (preset)” button until the output LED shows “P.” to enter the Preset Mapping Mode.
- 2) Use the “+” or “-” input push button to select the saved mapping configuration (1~8) which you want to recall
- 3) After you select the desired mapping configuration number, the LED will blink twice and the mapping setting will be effective
- 4) If you push the “output+ (save)” button before the mapping setting is effective, the LED will show “\_” “\_” to quit the Preset Mapping Mode

#### 4. Default EDID Mode

- 1) Push “input+ (default)”button to select the input channel which you want to learn default EDID and then keep pushing “input+ (default)”button when you select your desired input channel
- 2) Push the “+”or “-” output push button and then the LED will show “E”“d” one time to enter Learn Default EDID Mode
- 3) Use “+”or “-” output push button to select the default EDID mode(1~8)
- 4) Release “input+ (default)”button after selecting the desired default EDID mode, and then the LED will blink twice and the setting will be effective
- 5) It will quit the Learn Default EDID Mode if you push the “input- (learn)”button before the setting is effective
- 6) The LED will show “0”“0” if the setting is success  
The LED will show “F”“F” if the setting is failure

#### 5. EDID Learning Mode

- 1) Connect display to input 4(EDID port for learning EDID from display).
- 2) Push “input- (learn)”button to select the input channel which you want to learn EDID from EDID Port and then keep pushing “input- (learn)”button when you select your desired input channel
- 3) Push the “+”or “-” output push button and then the LED will show “E”“Number” to enter Learn Output EDID Mode.  
Ex: Learn EDID Port to Input 2  
The LED will show “E”“2”
- 4) Release “input- (learn)”button, and then the LED will blink twice and the setting will be effective
- 5) It will quit the Learn Output EDID Mode if you push the “input+ (default)”button before the setting is effective
- 6) The LED will show “0”“0” if the setting is success  
The LED will show “F”“F” if the setting is failure

## Method B: IR Remote Control

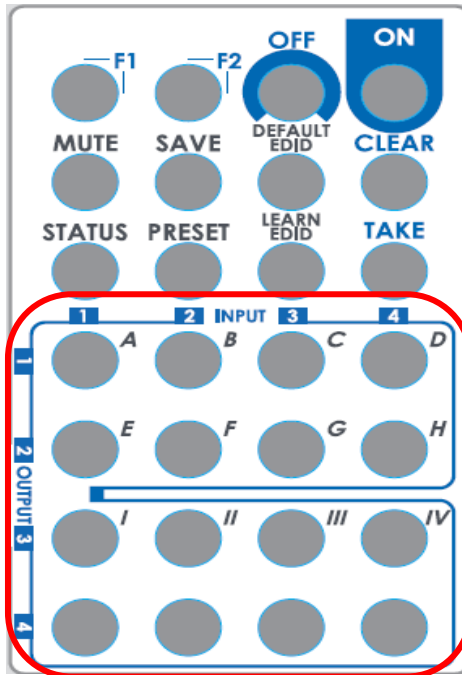

### 1. IN/OUT Switch

Push the button on the checkerboard to select Input & Output port.

Ex: Select Input 2 to Output 3

Push the red circle button as below to select Input 2 to Output 3

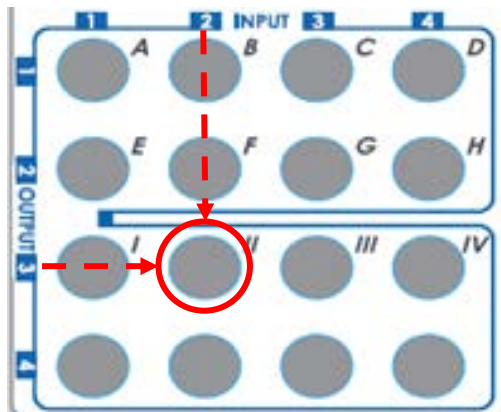

### 2. Function Key

Button	Function
OFF	Standby mode
ON	Power on the matrix switcher
MUTE	Turn off output's video and audio
STATUS	Preset output status
SAVE	Save current mapping mode
PRESET	Preset mapping mode
DEFAULT EDID	Begin default EDID selection
LEARN EDID	Begin EDID learning from one output
CLEAR	Clear the previous IR operation procedure
TAKE	Trigger the previous setting
F1	Reserved
F2	Reserved

Operation	Procedure	7-Segment LED
<b>Output Status</b> Ex: Output 4 (Input 2)	<b>Status + A~D(Output 1~4) + Take</b> 1.Press "STATUS" button 2.Press number key "D" to select Output 4 3.Press "TAKE" button	- - 4 - 4 2
<b>Save Current Mapping</b> Ex: Save current mapping to 5	<b>Save + A~H(1-8 storage site) + Take</b> 1.Press "SAVE" button 2.Press number key "E" to select the storage site 5 3.Press "TAKE" button	d - d 5
<b>Preset Mapping</b> Ex: Preset saved mapping from 5	<b>Preset + A~H(1-8 storage site) + Take</b> 1.Press "PRESET" button 2.Press number key "E" to select the storage site 5 3.Press "TAKE" button	P - P 5
<b>Learn default EDID</b> Ex: Default EDID 2 Input 3	<b>Default EDID + A~H(1-8 default EDID) + I ~ IV(input 1~4) + Take</b> 1.Press "DEFAULT EDID" button 2.Press number key "B" to select default EDID 2 3.Press number key " III " to select 4.Press "TAKE" button	E d 2 d 2 3 0 0 (success) F F(fail)
<b>Learn EDID Port EDID</b> Ex: Learn EDID Port Input 3	<b>Learn + D(EDID Port) + I ~ IV(input 1~4) + Take</b> 1.Press "LEARN" button 2.Press number key "D" to select EDID Port 3. Press number key " III " to select 4.Press "TAKE" button	E L 4 L 4 3 0 0 (success) F F(fail)
<b>Mute Output</b> Ex: Mute Output 3	<b>Mute + A~D(Output 1~4) + Take</b> 1. Press "MUTE" button 2. Press number key "C" to select Output 3 3.Press "TAKE" button	- 0 3 0 3 0

## Method C: Software Control through RS-232 port / Ethernet port

### 1. System Requirement

- 1) OS Information: MS WinXP/7
- 2) Baud rates: 9600
- 3) Software size: 3 MB
- 4) Minimum RAM requirement: 256 MB

## Method D: Software Control through RS-232 port

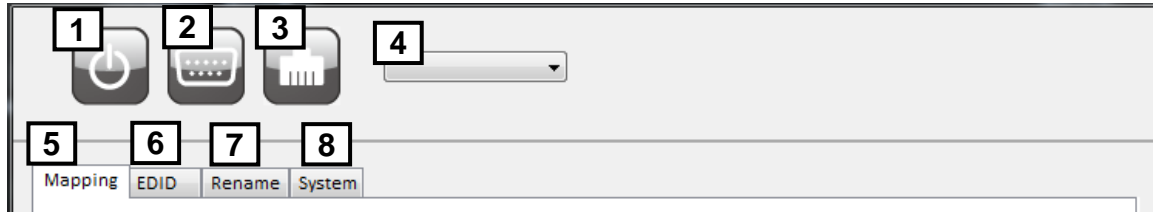

1	Power ON/ Standby mode	5	I/O Routing Button
2	Control SW via RS-232	6	EDID Button
3	Control SW via Network	7	Rename I/O Button
4	COM Port Selection	8	F/W Update & Default Reset Button

## 1. I/O Routing Button

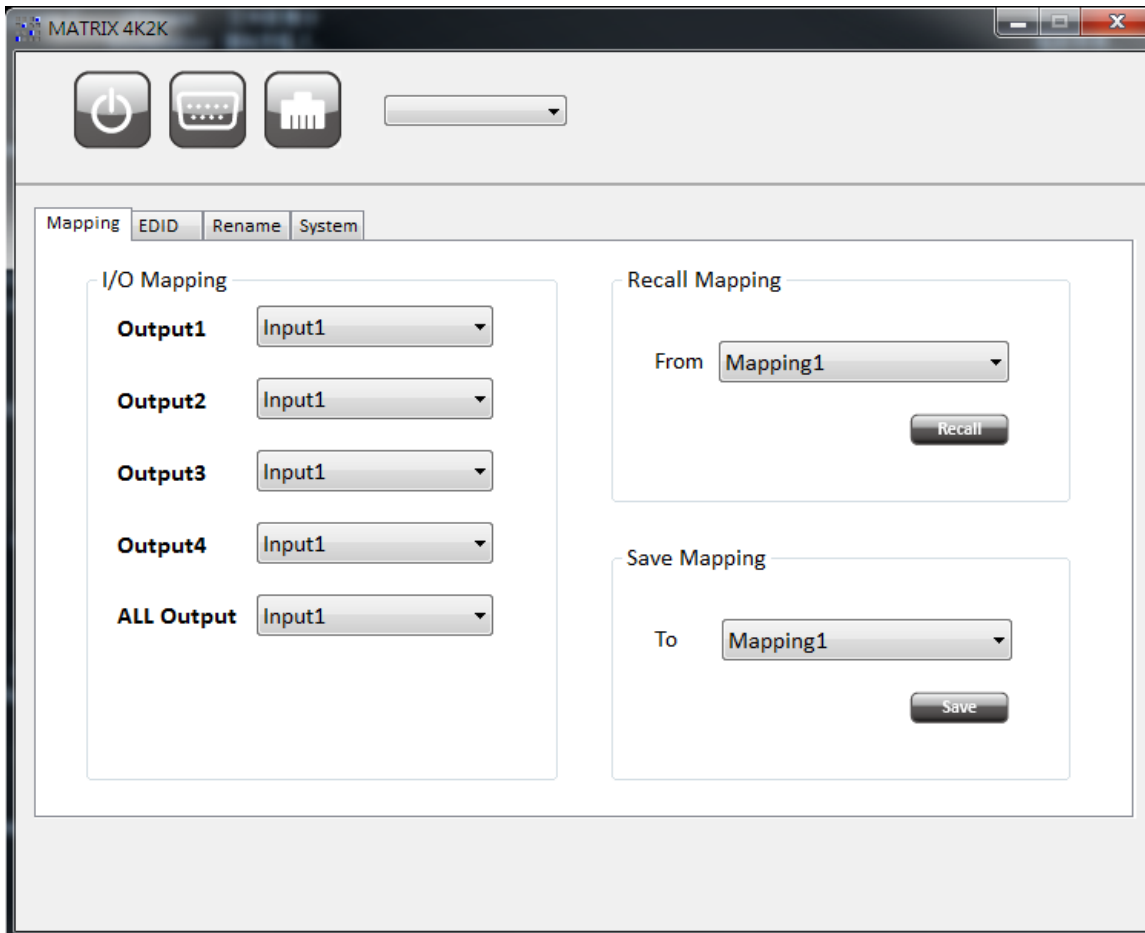

### 1) I/O Mapping:

- a) Switch the input for each output

### 2) Recall Mapping:

- a) Select the stored Mapping(1-8)
- b) Click "Recall" button to recall previous mapping which are saved

### 3) Save Mapping:

- a) Select Mapping(1-8)
- b) Click "Save" button to save current mapping

## 2. EDID Button

The screenshot shows the 'MATRIX 4K2K' software interface. At the top, there are three icons: a power button, a display icon, and a server rack icon, followed by a dropdown menu. Below this is a tabbed interface with 'Mapping', 'EDID', 'Rename', and 'System' tabs. The 'EDID' tab is active and contains two main sections: 'Learn EDID' and 'View EDID'. The 'Learn EDID' section has three dropdown menus: 'From Default', 'From Display', and 'To'. The 'To' dropdown is currently set to 'Input1'. Below these are 'Load File', 'Clear', and 'Apply' buttons. The 'View EDID' section has a dropdown menu set to 'Input1' and a 'View' button. A large empty text area is visible to the right of the 'View' button.

- 1) Learn EDID from Default to Input
  - a) Select Default EDID(1-11 Default EDID)
  - b) Select designated Input
  - c) Click “Apply” button to learn from default EDID
  
- 2) Learn EDID from Display to Input
  - a) Select output
  - b) Select designated Input
  - c) Click “Apply” button to learn from display EDID
  
- 3) Load EDID File to Input
  - a) Click “Load File” button to select the EDID file
  - b) Select designated Input
  - c) Click “Apply” button to load EDID File
  
- 4) View EDID
  - a) Select Input or HDMI/HDBT output
  - b) Click “View” button to read and analyze the EDID

### 3. Rename I/O Button

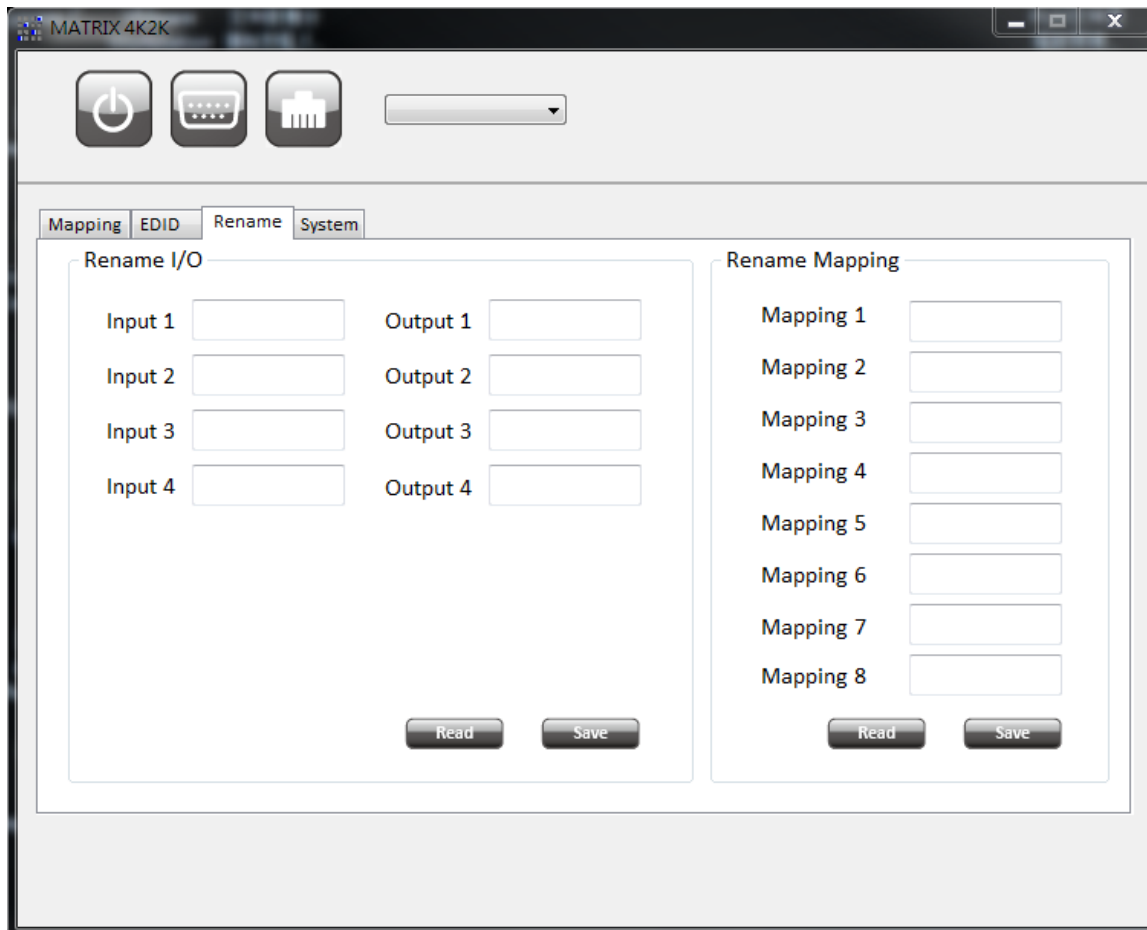

1) Rename I/O:

- a) Rename the Inputs
- b) Rename the Outputs

2) Rename Mapping:

- a) Rename the Mappings



## 4. System Button

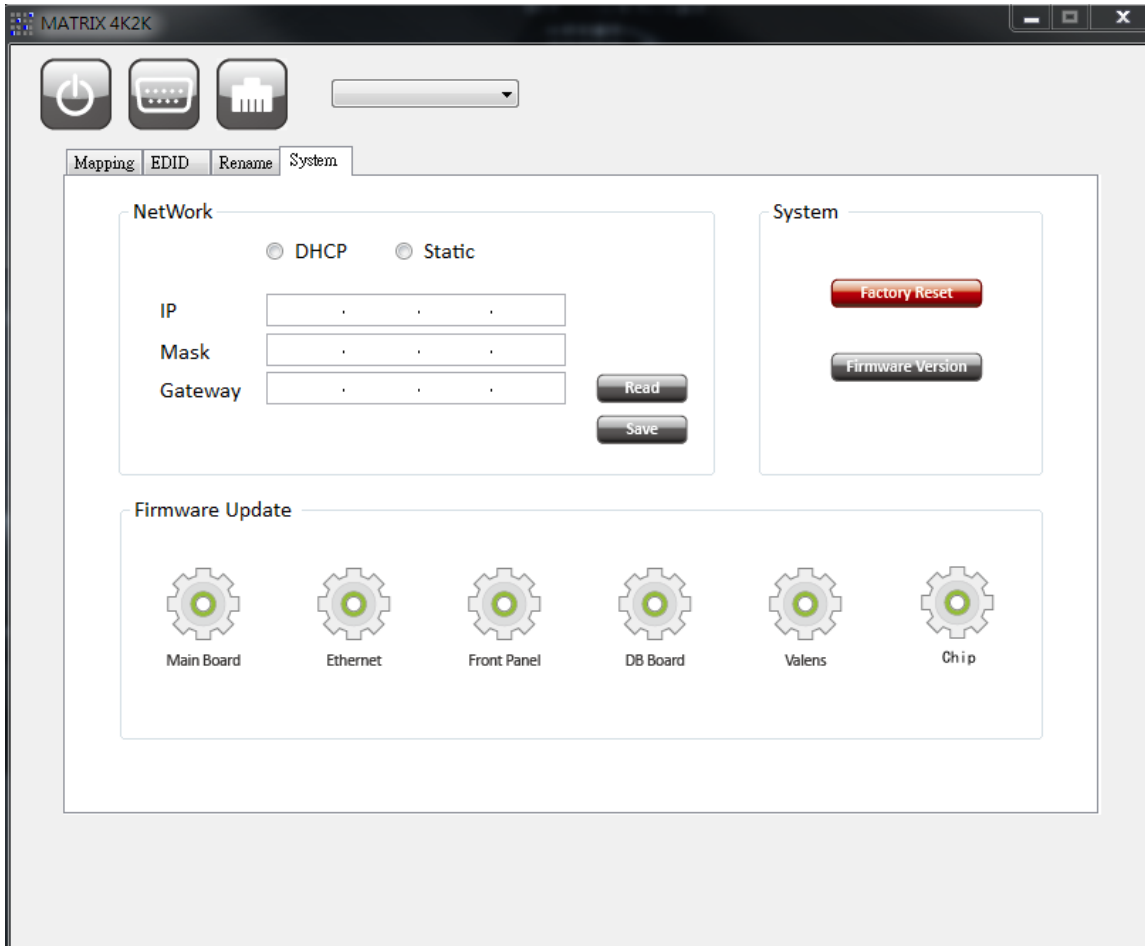

### 1) Network

#### a) DHCP mode

=> Click DHCP and then click the "Read" button to get the IP address Info

#### b) Static mode

=> Click Static and then key in the "IP", "MASK", "GATEWAY" info. After setting IP Address, please click "Save" to save IP address Info

#### c) "Save" button

=> Save the key- in IP address

#### d) "Read" button:

=> Read the IP address from the device

\*Note: The default IP address is **192.168.1.111**

### 2) System

#### a) Factory Reset

#### b) Firmware Version

=> To get the F/W version information

### 3) Firmware Update

=> Firmware update Main Board/ Ethernet/ Front Panel/ DB Board/ Valens/ Chip

## Method E: Web Interface Control

The default IP address: 192.168.1.111

Account: admin

Password: matrix

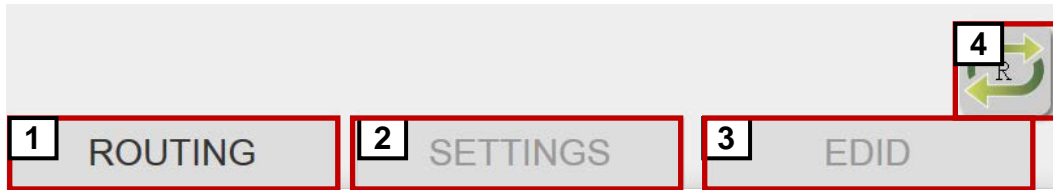

1	I/O Routing Button
2	Setting Button
3	EDID Button
4	Refresh I/O Status & Read I/O Name Button

### 1. I/O Routing Button

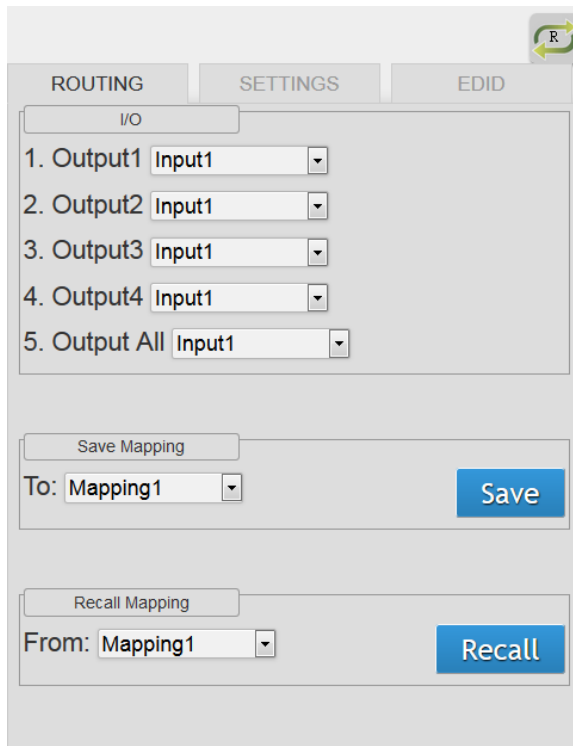

- 1) I/O:
  - a) Switch the input for each output
- 2) Save Mapping:
  - a) Select Mapping(1-8)
  - b) Click "Save" button to save current mapping
- 3) Recall Mapping:
  - a) Select the stored Mapping(1-8)
  - b) Click "Recall" button to recall previous saved mapping

## 2. Setting Button

The screenshot shows a web interface with three main sections under the 'SETTINGS' tab. At the top right, there is a green circular refresh icon. The first section, 'Rename I/O', has a sub-tab 'Rename I/O' and contains two columns of input fields. The left column is labeled 'Output / Name' and has four fields: '1 Output1', '2 Output2', '3 Output3', and '4 Output4'. The right column is labeled 'Input / Name' and has four fields: '1 Input1', '2 Input2', '3 Input3', and '4 Input4'. A blue 'Send' button is at the bottom right of this section. The second section, 'Rename Mapping', has a sub-tab 'Rename Mapping' and contains two columns of input fields. The left column is labeled 'Configuration / Name' and has four fields: '1 Mapping1', '2 Mapping2', '3 Mapping3', and '4 Mapping4'. The right column has four fields: '5 Mapping5', '6 Mapping6', '7 Mapping7', and '8 Mapping8'. A blue 'Send' button is at the bottom right of this section. The third section, 'Password Changing', has a sub-tab 'Password Changing' and contains three input fields: 'Old Password', 'New Password', and 'New Password Confirm'. A blue 'Submit' button is at the bottom right of this section.

- 1) Rename I/O:
  - a) Rename the Outputs
  - b) Rename the Inputs
- 2) Rename Mapping:
  - a) Rename the Mappings
- 3) Password changing: (the password has to be 6 characters)
  - a) Key in "old password"
  - b) Key in "new password"
  - c) Key in "new password" again to confirm

### 3. EDID Button

ROUTING    SETTINGS    EDID

Learn EDID From Default

From 1.Full-HD-24bit 2D & 2ch    Send

To Input 1

Learn EDID From Display

From 1.HDMI Output 1    Send

To Input 1

- 1) Learn EDID from Default
  - a) Select Default EDID(1-11 Default EDID)
  - b) Select Input
  - c) Click “Send” button to learn default EDID
- 2) Learn EDID From Display
  - a) Select output
  - b) Select Input
  - c) Click “Send” button to learn display EDID

### 4. Refresh I/O Status & Read I/O Name Button

The EDID learning function is to resolve audio and video playing issues at HDMI output port. Because the HDMI source devices and displays may have various level of capability in playing audio and video, the general principle is that the source device will output the lowest standards in audio format and video resolutions to be commonly acceptable among all HDMI displays. In this case, a 720p stereo HDMI signal output would be probably the safest choice. Nevertheless, the user can force the matrix to learn the EDID of the lowest capable HDMI display among others to make sure all displays are capable of playing the HDMI signals normally.

There are **THREE methods** to do EDID Learning as below,

1. IR Remote Control: Please refer to the **Operation Approach\ Method B: IR Remote Control**
2. Software Control: Please refer to the **Operation Approach\ Method C: Software Control through RS-232 port**
3. Web Interface Control: Please refer to the **Operation Approach\ Method D: Web Interface Control**

There are **eleven embedded default EDID** as below,

1. 4k2k@30-24bit 2D & 2ch
2. 4k2k@30-24bit 2D & 7.1ch
3. Full-HD(1080p@60)-24bit 2D & 2ch
4. Full-HD(1080p@60)-24bit 2D & 7.1ch
5. Full-HD(1080p@60)-24bit 3D & 2ch
6. Full-HD(1080p@60)-24bit 3D & 7.1ch
7. HD(1080i@60)(720p@60)-24bit 2D & 2ch
8. HD(1080i@60)(720p@60)-24bit 2D & 7.1ch
9. Full-HD(1080p@60)-36bit 2D & 2ch [ONLY can be used via SW & Web control]
10. Full-HD(1080p@60)-36bit 2D & 7.1ch [ONLY can be used via SW & Web control]
11. Full-HD(1080p@60)-24bit 2D & 2ch & Dolby 5.1ch [ONLY can be used via SW & Web control]

## Q Can I use any kind of LAN cable?

A Please check the NOTICE section for more information about how to pick up a suitable cable.

## Q Can every TV work with the HDMI matrix?

A Basically, the answer is YES. But if your TV can not support UltraHD, please refer the EDID LEARNING section to learn EDID from your TV.

## Q What is EDID? Why do I need to learn EDID?

A EDID contains the whole information of the display such as the resolution and audio setting which this display can support. Therefore, based on the EDID information, media player will pick up the most suitable resolution and audio setting to the display. In order to faithfully transmit the EDID information from display to the media player, learning EDID from display to this device is necessary.

## Q What should I do to learn EDID for the matrix?

A Due to the limitation of HDMI, the source device can only output one format of video and audio. In other words, the source device cannot output 720p and 1080p video at the same time, or output stereo and surround sound at the same time. Therefore, you may need to manually setup each HDMI input for desirable audio/video output format. The mechanism of EDID Learning is to pick up the HDMI display with the lowest capability among the ones you would use for this input source. For example, if user would like to play the Input-2 upon output-2, output-3 and output-4, and only output-3 cannot support 1080p [support up to 720p only], please learn the EDID from the display connected to the output-3 at the Input-2 port. Of course, if output-3 would get the HDMI signals from every HDMI input, please learn EDID information from output3 to all four HDMI inputs. For more information about EDID Learning, please refer to EDID LEARNING section.

## Q My TV can support 1080p, but why there is no audio?

A The factory default EDID of this device is 1080p & 2ch audio. However, there would be a problem after you change to use 1080p & 7.1ch if the TV cannot support 7.1ch audio. Please use the default EDID, 1080p & 2ch audio.

## Q When I set an audio amplifier (AV receiver) between TV and the matrix to extract 7.1ch audio, but why there is still no audio?

A Basically, the default EDID of the chosen input can support 7.1ch audio, but the problem is that the EDID of the amplifier still cannot match the default setting. Therefore, the best method is to learn EDID from the amplifier directly. Please refer to EDID LEARNING section and follow the steps to learn the EDID. When learning EDID from the amplifier, user just needs to connect the matrix and amplifier. **Please don't connect HDMI cable between amplifier and TV when the EDID learning is proceeding.**

## Q When I play the same content upon multi-displays, why only the TV equipped with amplifier can have 7.1ch audio, and the others don't have 7.1ch audio even no stereo?

A Due to the limitation of HDMI, the source only can choose one video and one audio format to play, which can be either 1080p and 7.1ch or 1080p and stereo audio. It means when the user sets the matrix at 1080p and 7.1ch, the source will only play the content under this format. Therefore if the TV cannot decode 7.1ch audio, there is definitely no audio.

# NOTICE

1. If the DVI or HDMI device requires the EDID information, please use EDID Reader/Writer to retrieve and provide DVI/HDMI EDID information.
2. All HDMI over Cat.X transmission distances are measured using Belden 1583A CAT5e 125MHz LAN cable and ASTRODESIGN Video Signal Generator VG-859C & VG-870B.
3. EIA/TIA-568-B termination (T568B) for LAN cables is recommended for better performance.
4. To reduce the interference among the unshielded twisted pairs of wires in LAN cable, one can use shielded LAN cables to improve EMI problems, which is worsen in long transmission.
5. Because the quality of the LAN cables has the major effect on how long the transmission limit can achieve and how good is the received picture quality, the actual transmission range is subject to one's choice of LAN cables. For desired resolutions greater than 1080i or 1280x1024, a Cat-6 cable is recommended.
6. If your HDMI display has multiple HDMI inputs, it is found that the first HDMI input [HDMI input #1] generally can produce better transmission performance among all HDMI inputs.
7. Additional IR remote controls and IR blasters can be purchased as optional accessories to control the HDMI sources located separately.

# WARRANTY

The SELLER warrants the **MA-5444V2 4x4 HDBaseT Lite matrix with PoC, HDCP2.2 & 4K2K60 (YUV420)** free from defects in the material and workmanship for 1 year from the date of purchase from the SELLER or an authorized dealer. Should this product fail to be in good working order within 1 year warranty period, The SELLER, at its option, repair or replace the unit, provided that the unit has not been subjected to accident, disaster, abuse or any unauthorized modifications including static discharge and power surge. This warranty is offered by the SELLER for its BUYER with direct transaction only. This warranty is void if the warranty seal on the metal housing is broken.

Unit that fails under conditions other than those covered will be repaired at the current price of parts and labor in effect at the time of repair. Such repairs are warranted for 90 days from the day of reshipment to the BUYER. If the unit is delivered by mail, customers agree to insure the unit or assume the risk of loss or damage in transit. Under no circumstances will a unit be accepted without a return authorization number.

The warranty is in lieu of all other warranties expressed or implied, including without limitations, any other implied warranty or fitness or merchantability for any particular purpose, all of which are expressly disclaimed.

Proof of sale may be required in order to claim warranty. Customers outside Taiwan are responsible for shipping charges to and from the SELLER. Cables and power adapters are limited to a 30 day warranty and must be free from any markings, scratches, and neatly coiled.

The content of this manual has been carefully checked and is believed to be accurate. However, The SELLER assumes no responsibility for any inaccuracies that may be contained in this manual. The SELLER will NOT be liable for direct, indirect, incidental, special, or consequential damages resulting from any defect or omission in this manual, even if advised of the possibility of such damages. **Also, the technical information contained herein regarding the MA-5444V2 features and specifications is subject to change without further notice.**